

# RÄDER-VOGEL®

FOR BETTER WHEELS AND BETTER SERVICE



## AVIATION TECHNOLOGY



OUR CLIENTS



Hamburg Airport "Helmut Schmidt" • Bremen Airport  
 Düsseldorf Airport • Hanover Airport • Cologne/Bonn  
 Airport "Konrad Adenauer" • Leipzig/Halle Airport  
 Gdansk Lech-Wałęsa-Airport • Johannesburg Airport  
 "O. R. Tambo" • Cape Town International Airport  
 Singapore Changi Airport



REDISCOVER THE WHEEL

All wheels have one thing in common – they are round. Looking beyond this, however, every area of application has its own specific requirements in terms of size, materials and load capacity. Therefore, since 1946, we have been developing wheels and castors to meet the constantly increasing demands of the market: from individual customised items to standardised large batches.

Our high standards, quality and innovative strength have made us one of the world's leading manufacturers of wheels, pallet rollers, press-on tyres and swivel and fixed castors. Our products are used at every airport in the world. Our wheels and castors are used in baggage and cargo logistics, in hangars and shipyards, as well as on airport aprons and in terminals.

We are a member of:





## High-quality wheel materials for your applications

The more diverse and challenging the areas of application of our wheels and castors, the broader the range of wheel-tread materials we offer. One area of focus is our VULKOLLAN®\* and polyurethane elastomers, all of which are produced by a hot-casting process. These are non-marking and they stand out for their low starting and rolling resistance, high dynamic load capacity, and good abrasion and tear resistance.

We also offer a wide range of wheel-treads made of thermoplastic polyurethane, polyamide and rubber. These are particularly suitable for industrial castors used in factory environments for the internal transport of goods in indoor and outdoor areas.

\* VULKOLLAN® and DESMODUR® are registered trademarks of the Covestro Group.

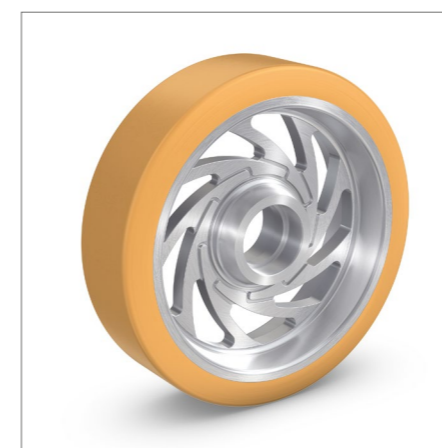

### VULKOLLAN® 93 AND 95 SHORE A / hydrolysis-stabilised

VULKOLLAN® is a highly elastic, cross-linked polyurethane elastomer based on DESMODUR® 15\* with excellent mechanical properties. This includes high dynamic loading capacity, high abrasion resistance and tear-propagation resistance, the highest modulus of elasticity of all elastomers, high mechanical-wear resistance as well as high impact resilience and a low compression set. For applications in

tropical environments, we recommend hydrolysis-stabilised VULKOLLAN®.

#### Areas of application

- Docking systems
- Tugs and transporters
- Conveyor tracks
- Engine positioners (Mecanum)

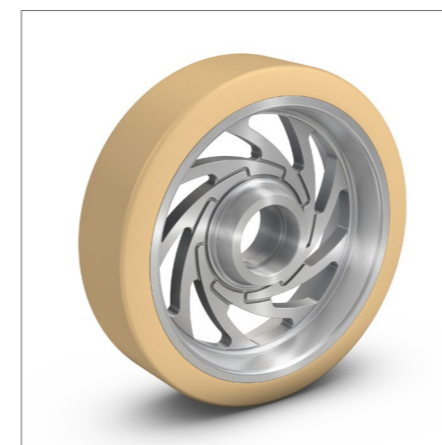

### PEVODYN®

PEVODYN® is a new high-quality polyurethane elastomer that we have developed with a long service life, offering significantly reduced starting and rolling resistance, high dynamic load capacity and high energy efficiency. Therefore, the material is particularly suitable for intralogistic applications involving the transport of large loads at a high speed. Thanks to its hydrolysis resistance, PEVODYN® is ideal for use in tropical climates.

#### Areas of application

- Lift trucks for air freight

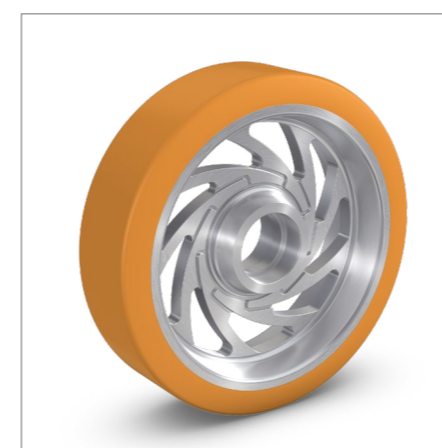

### PEVOPUR®

PEVOPUR® is a high-quality polyurethane elastomer which offers good dynamic load capacity, high elasticity, good mechanical wear resistance and good compressive set characteristics. PEVOPUR® is also significantly more resilient than rubber. This makes the material especially suitable for applications involving medium loads and moderate speeds, and it is ideal for use in tropical climates.

#### Areas of application

- Docking systems
- Lift trucks for air freight
- GSE (ground support equipment)
- Tripod jacks
- Mobile passenger bridges

# High-quality wheel materials for your applications



## PEVODYN® Soft

PEVODYN® Soft 78 Shore A is a new high-quality polyurethane elastomer that we have developed with high dynamic load capacity and significantly reduced starting and rolling resistance. The excellent mechanical properties of the material include high cutting, tearing and abrasion resistance as well as high energy efficiency. Thanks to its good noise reduction and vibration damping, PEVODYN® Soft is particularly suitable for the transport of medium loads at high speeds on surfaces

where care is needed. And with its hydrolysis resistance, the material is ideal for use in tropical climates.

### Areas of application

- Lift trucks for air freight
- Airport trailers
- Tugs and transporters



## Rubber

In comparison with polyamides and polyurethane, rubber has a higher rolling resistance and is particularly floor preserving. Thanks to the variety of attributes and wheel body materials, rubber wheels can be used for a wide range of applications in in-plant transportation. We can offer you solid rubber and ELASTIC solid rubber wheels, thermoplastic rubber wheels and wheels with SUPER-ELASTIC tyres and pneumatic tyres.

### Areas of application

- GSE (ground support equipment)
- Mobile passenger bridges
- Airport trailers



## PEVOLON®/PEVOLON® ELF

PEVOLON® is a thermoplastic material based on polyamide that stands out for its non-marking properties, good chemical resistance, high abrasion resistance, low rolling resistance and a high load capacity of up to two tonnes. Furthermore, the material is very resistant to heat and cold (-40°C to +90°C), although the load capacity is reduced for temperatures above 35°C.

### Areas of application

- Mobile work platforms
- Tripod jacks
- Docking systems

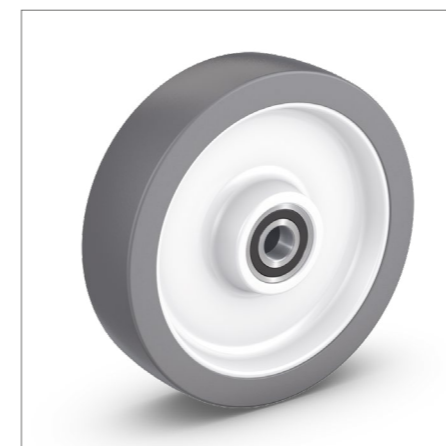

## PEVOTHAN®/PEVOTHAN® ELF

PEVOTHAN® is a high-quality thermoplastic polyurethane elastomer with excellent characteristics, including non-marking properties, high abrasion resistance, good damping power, loading capacities of up to 500 kg and temperature resistance of between -20°C and +80°C. PEVOTHAN® is also widely resistant to diluted acids and alkalis as well as mineral greases and oils. Thanks to these properties, PEVOTHAN® is superior to all normal rubber wheels and is

particularly recommended for sensitive surfaces.

### Areas of application

- Trolleys
- Platforms

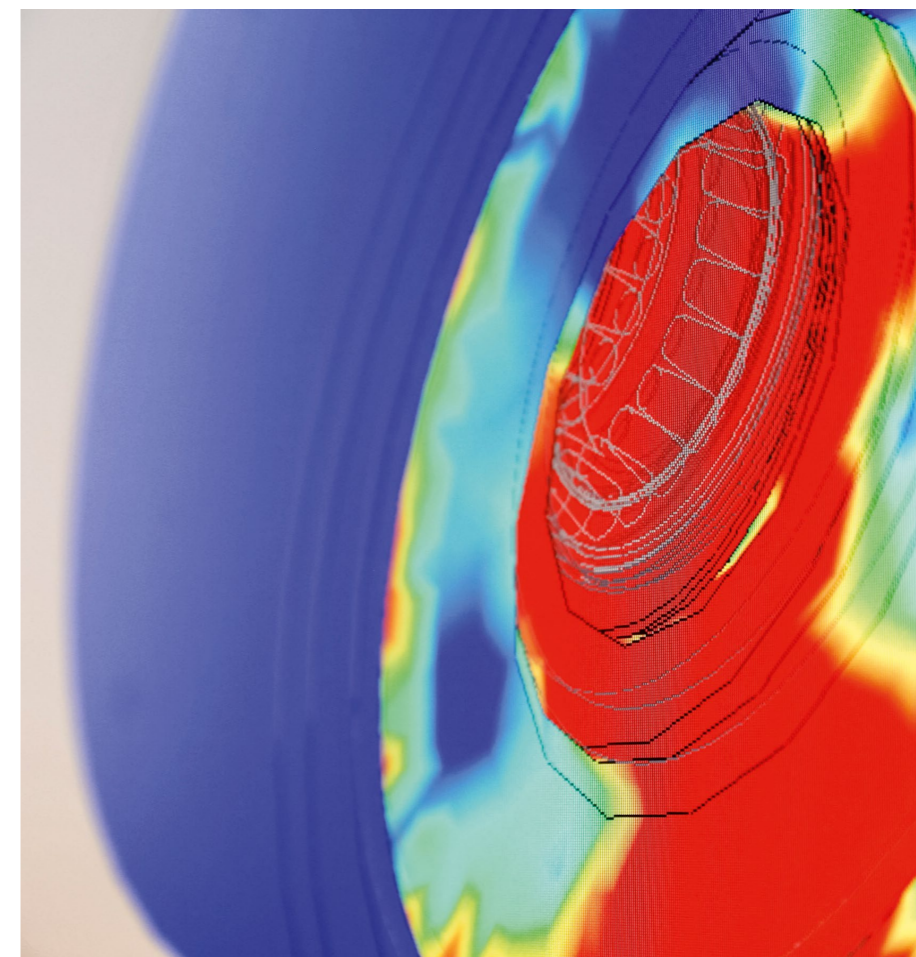

## PEVOTEC®

Our brand PEVOTEC® includes an extensive range of special polyurethane elastomers which are used under extreme operating conditions. Depending on the task at hand, we develop the ideal wheel material for you by adapting the chemical and physical properties of the materials to suit your requirements.



## Light and flexible to the next level

Wheels and castors for mobile stairs/  
maintenance platforms

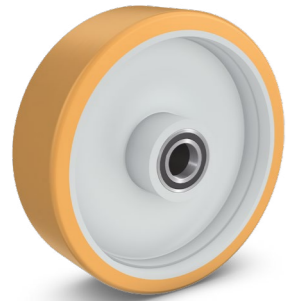

VULKOLLAN® load wheels



PEVOLON® heavy-duty castors



PEVOPUR® heavy-duty  
swivel castors



VULKOLLAN® heavy-duty  
swivel castors

Our wheels and castors for mobile stairs and docking systems have proven successful in the maintenance and production of aeroplanes throughout the world. They feature low starting and rolling resistance and make it easier to ensure precise positioning. High load capacities are possible through the use of high-quality wheel material.



Source: ZARGES GmbH



Source: ZARGES GmbH



Source: ZARGES GmbH

## Precise positioning, powerful lifting and secure support

Wheels and castors for engine positioning  
apparatus and tripod jacks

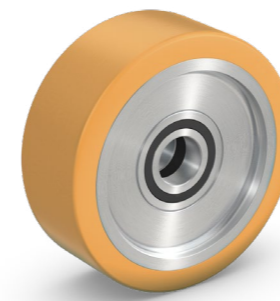

VULKOLLAN® load wheels



VULKOLLAN® industrial  
swivel castors



PEVOPUR® heavy-duty  
swivel castors



Spring-loaded solid rubber  
heavy-duty castors

Lifting and support equipment play an essential part in aerospace technology. In addition to the high load capacity and durability of all components, maximum precision is also required. The use of Mecanum wheels enables precise, direct positioning without any extensive time-consuming manoeuvres.



Source: JMS AG Flightzeppelin GmbH



Source: JMS AG Jet Maintenance & Service

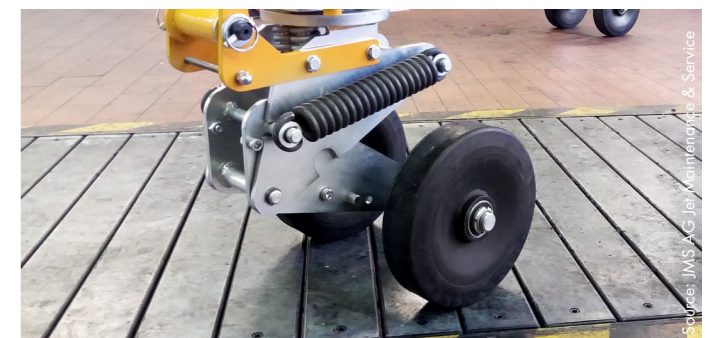

Source: JMS AG Jet Maintenance & Service



## Rapid loading and unloading

Wheels and press-on tyres for lifting vehicles

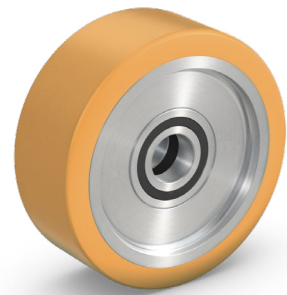

VULKOLLAN® load wheels

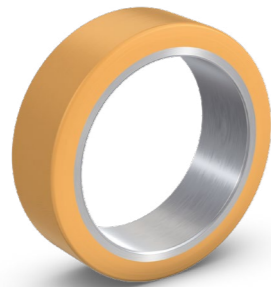

VULKOLLAN®/PEVOPUR®  
press-on tyres



Heavy-duty wheels with  
pneumatic and SE tyres



Ball units

In the case of large cargo volumes and tight schedules, aeroplanes need to be loaded and unloaded quickly and reliably. Our products ensure this is possible thanks to their high load capacity and compact design. Even in extreme weather or in tropical conditions, the exceptional rolling properties are unaffected.



Source: RÄDER-VOGEL



Source: DIMOS Maschinenbau GmbH



Source: MAC Fachzeugbau GmbH

## Automatic, reliable processing

Wheels for baggage and cargo handling



PEVOPUR® wheels

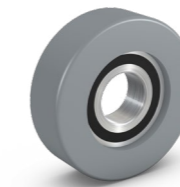

PEVOLON®, PEVOTHAN®,  
PEVOTHAN® HD guiding wheels

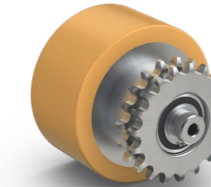

VULKOLLAN® chain wheel



Ball units

Baggage and cargo need to be brought to and from aircraft continuously and without any issues. This is ensured through the use of our wheel materials with properties tailored to specific tasks. They are highly durable, offer excellent impact resilience and also work reliably at high speeds.



Source: RÄDER-VOGEL

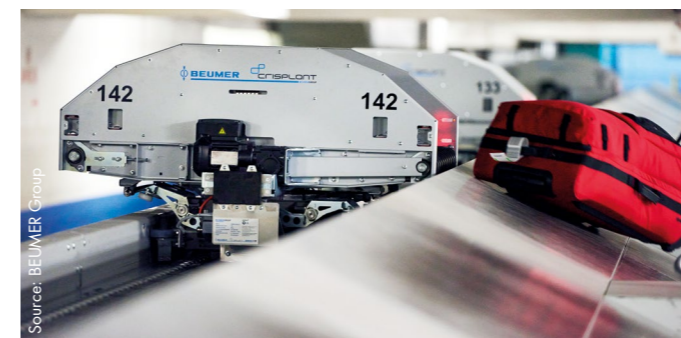

Source: BEUMER Group



Source: BEUMER Group



## Pinpoint motion

Wheels and castors for ground support equipment (GSE)



PEVOPUR® heavy-duty castors

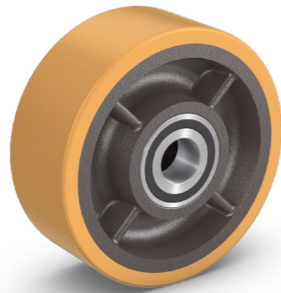

VULKOLLAN® load wheels

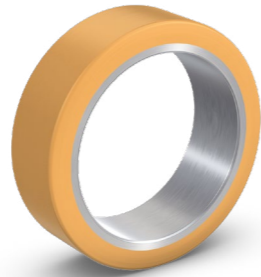

VULKOLLAN®/PEVOPUR® press-on tyres



Heavy-duty wheels with SUPER-ELASTIC tyres

Nothing would move on airport aprons without the use of wheels and castors. To ensure that everything keeps moving, our wheels and rollers work reliably under extreme weather conditions thanks to the specially developed materials. They also excel in long durability through low wear and tear, even on rough surfaces.



## Flexible, multifaceted in operation

Wheels and castors for in-house transportation



VULKOLLAN® drive wheels

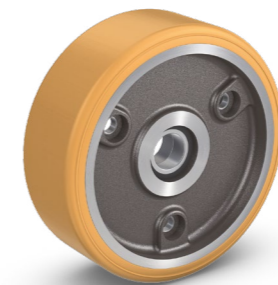

VULKOLLAN® load wheels



VULKOLLAN®/PEVODYN® Soft drive wheels



PEVOPUR® industrial swivel castors

Our products are used in manually transportable systems, on industrial trucks and in automated storage systems as they ensure trouble-free operation as well as reliable, rapid handling. Moreover, they operate impressively in all areas of application, both simple and more challenging.



Source: Linde Material Handling GmbH



Source: STILL GmbH

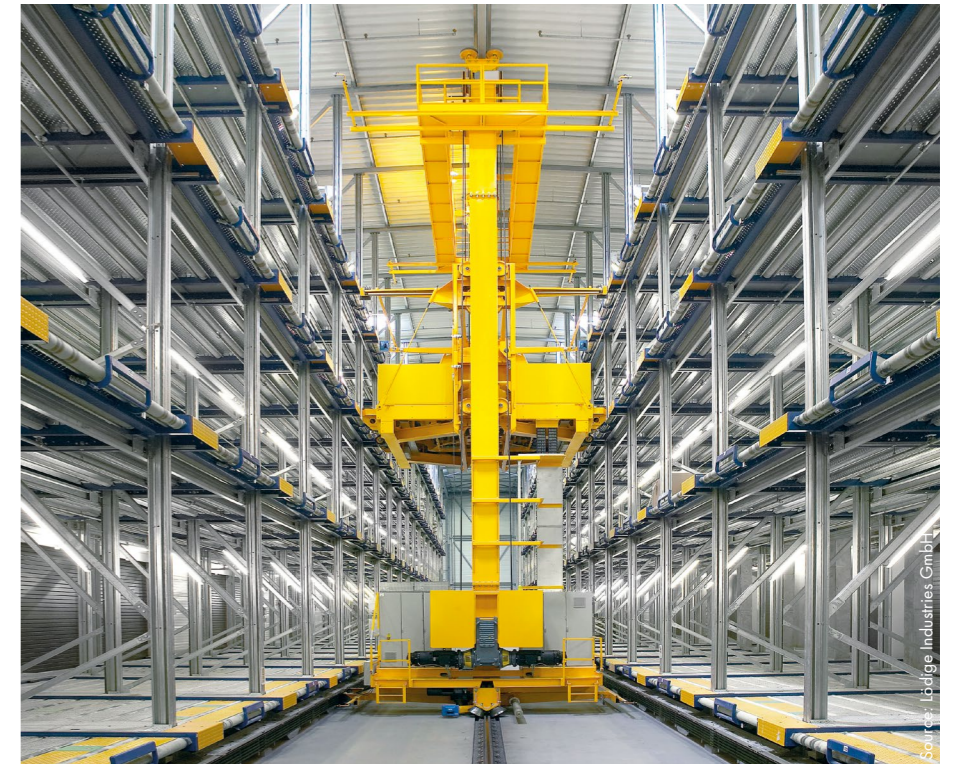

Source: Librije Industries GmbH



## Your requirements set the benchmark

Whether for individual pieces or large batches, we are specialists and the market leader in custom-made products in Germany. Working closely with you, we develop high-quality solutions for a diverse range of requirements. You can count on our years of experience and expertise in almost every industry.

### EVERYTHING IS POSSIBLE

Forty employees in our construction and development department strive to make your wishes a reality every day. Our range of services includes the entire production development cycle – from the initial idea and construction to testing, all the way through to production. Depending on the requirements and area of application, we can either draw on existing products and adapt them to fit your needs or we can construct new, innovative solutions in collaboration with you.

Based on 3D construction data, we carry out strength calculations and simulations of load cases using specialised FEM modules. This allows us to check all key parameters of your wheel by computer.



### INNOVATIVE WHEEL TREAD MATERIALS

In addition to the construction of custom-made products, we constantly work to further develop our existing product range and to implement market requirements into new products. We are the most innovative company in the development of wheel tread materials in the world and we cooperate closely in this respect with a number of colleges and with our partners. Over the past few decades, we have developed and patented several materials, such as PEVODYN®, VULKODYN® and TRACTOTHAN®.



### TRUST IN OUR PRODUCTS

Our wheels have to prove themselves every day in the most demanding operating conditions. Excellent quality and a long service life are therefore an absolute necessity for us. Our quality assurance system is certified according to DIN EN ISO 9001, DIN EN ISO 3834-2, DIN EN ISO 14001 and other standards. We have also implemented our own advance warning system within our processes. We carry out dynamic testing of wheels in accordance with DIN EN 12527–12533 on our own specially developed roller drum test rig, which allows us to simulate a large number of different usage situations. This means that when you choose us, you can always be sure that you will receive the best-possible product.



## Throughout the world



### GLOBAL SALES

You can get our wheels and castors exclusively from independent retail partners in more than 50 countries throughout the world. We have built up close and trusting relationships with many of them – relationships that stretch back over decades. Our partners offer you optimal service on-site, as well as high product availability thanks to their own storage facilities. We

also offer them regular support through intensive product training, technical consultation and joint customer visits. We ship our products across the whole world from Hamburg. Thanks to the excellent infrastructure connections and our certification as a known consignor, all goods arrive quickly at their destinations.





**RÄDER-VOGEL**

RÄDER- UND ROLLENFABRIK GMBH & CO. KG  
Sperlsdeicher Weg 19-23 • 21109 Hamburg, Germany  
phone: +49 40 75499-0 • fax: +49 40 75499-175

[www.raedervogel.de](http://www.raedervogel.de) • [rv@raedervogel.de](mailto:rv@raedervogel.de)